

BIMAX-TRES

Lavabos

Ref.:

Bimando lavabo

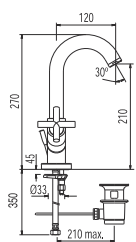

Cr 1.63.103



Cr 1.68.103



Batería lavabo

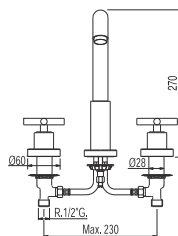

Cr 1.68.105



Batería lavabo mural
caño largo 250 mm.

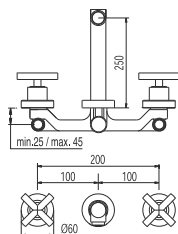

Cr 1.63.151



Monomando lavabo
cartucho progresivo

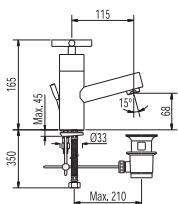

91.34.588 Cr 1.63.103.10





91.34.588 Cr 1.68.103.10





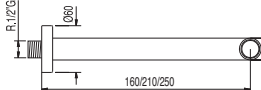

Cr = Cromo

Recomendado montar válvula SIMPLE RAPID (NO INCLUIDA)

BIMAX-TRES

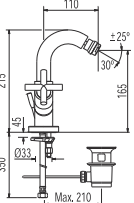
		Ref.:	
	Caño pared	(16 cm.)	
		Cr	1.61.170.02
			Cr
	Cr		1.61.171.02

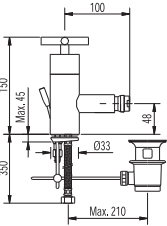
Bidé

		Ref.:	
	Bimando bidé		
		Cr	1.63.120
		Cr	1.68.120
	Monomando bidé cartucho progresivo		
		Cr	1.63.120.10
		Cr	1.68.120.10

Bimando baño

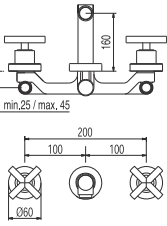
		Ref.:	
	Batería bañera mural caño corto 160 mm.		
		Cr	1.63.152

Cr = Cromo



 Recomendado montar válvula SIMPLE RAPID (NO INCLUIDA)

			Ref.:	
--	--	--	-------	--



Grupo ducha
Ducha móvil anticalcárea (034.116.01) y flexo SATIN (91.34.609.15).

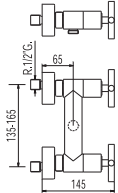







LATÓN

Cr	1.63.868	
----	----------	--



Grupo bañera
Ducha móvil anticalcárea (034.116.01) y flexo SATIN (91.34.609).

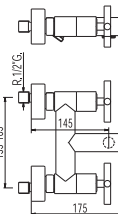





LATÓN

Cr	1.63.874	
----	----------	--



Grupo bañera con tomas a suelo
Ducha móvil anticalcárea (034.116.01) y flexo SATIN (91.34.609).



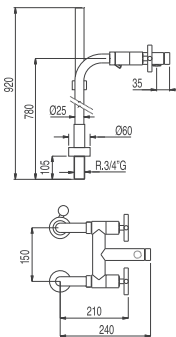
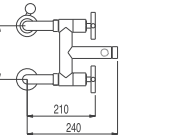





LATÓN

Cr	1.63.194	
----	----------	--

Empotrados



Monomando empotrar ducha

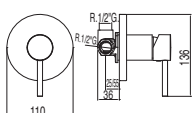





LATÓN

Cr	1.62.177.05	
----	-------------	--

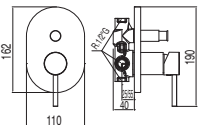

Monomando empotrar baño-ducha





LATÓN

Cr	1.62.180.05	
----	-------------	--

Cr = Cromo

BIMAX-TRES

Ref.:



Monomando empotrar ducha

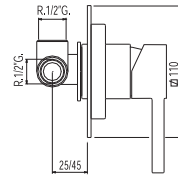

91.34.288

Cr

1.62.177



Monomando empotrar baño-ducha

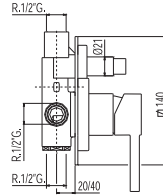

91.34.288

Cr

1.62.180

Conjuntos empotrados

Ref.:



Kit de ducha empotrado BIMAX
con cierre y regulación de caudal. Ducha fija Ø 300 mm. (1.34.137.30).
Material Latón.

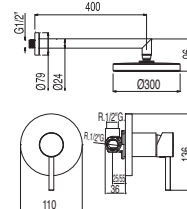

91.34.592

Cr

1.62.377.05



Kit de ducha empotrado BIMAX
con cierre y regulación de caudal. Ducha fija Ø 300 mm. (1.34.137.30).
Material Latón. Soporte con toma pared (91.34.182). Ducha móvil anticalcárea
(034.116.01) y flexo SATIN (91.34.609.15).

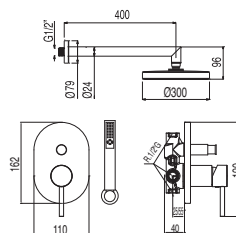

91.34.592

Cr

1.62.880.05

Cr = Cromo

Ref.:



N

Kit de ducha empotrado BIMAX

con cierre y regulación de caudal. Ducha fija Ø 300 mm. Material Latón (1.34.137.30). Codo toma pared (1.34.758). Barra deslizante long. 550 mm. (1.34.618). Ducha móvil anticalcárea (034.116.01). Flexo SATIN (91.34.609.15).

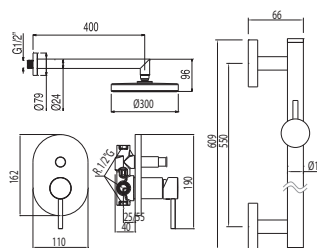

LATÓN



LATÓN



91.34.592

Cr

063.980.06

Bañeras de repisa

Ref.:

Batería bañera de repisa

Ducha móvil anticalcárea (034.116.01)

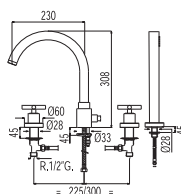

LATÓN



3 bar
17 l/m



Cr

1.63.145



Kit depósito para bañeras de repisa

Fácil montaje superior. Sin registros

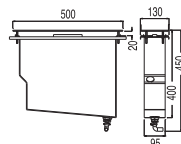

Sistema Patentado®

Cr

1.34.345



Válvula bañera con toma drenaje

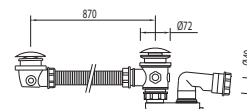

Cr

1.34.445

Cr = Cromo

BIMAX-TRES

Termostáticas

Ref.:

N

Ducha BIMAX termostática
(Ducha móvil anticalcárea (034.116.01) y flexo SATIN (91.34.609.15)).

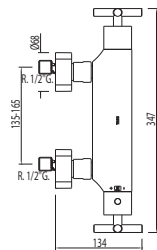

Cr 063.162.01



LATÓN

Cr 063.162.09

N

Bañera-ducha BIMAX termostática
Con cascada. (Ducha móvil anticalcárea (034.116.01) y flexo SATIN (91.34.609)).

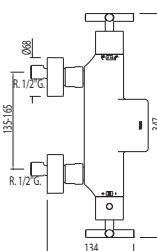

Cr 063.172.01



LATÓN

Cr 063.172.09

2 tomas suelo de bañera
Con soporte giratorio

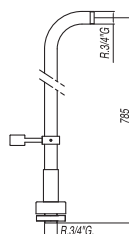

Cr 1.61.194

Conjuntos termostáticos

Ref.:

N

Conjunto ducha BIMAX termostática

Ducha fija Ø 300 mm. (1.34.137.30). Material Latón. Ducha móvil anticalcárea (034.116.01) y flexo SATIN (91.34.609.15). Inversor integrado en el regulador de caudal (ver pág. 576)



TRES TOUCH-COOL®

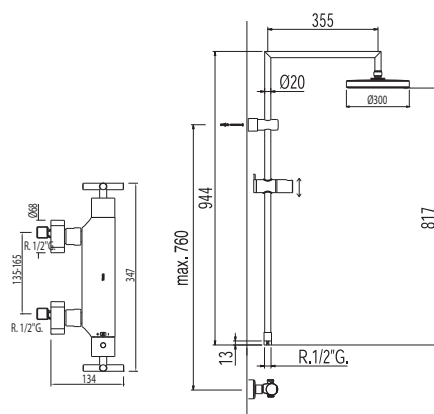

LATÓN



LATÓN

Cr

063.393.01

N

Conjunto ducha BIMAX termostática

Ducha fija Ø 300 mm. (1.34.137.30). Material Latón. Ducha móvil anticalcárea (034.116.01) y flexo SATIN (91.34.609.15). Barra telescópica. Inversor integrado en el regulador de caudal (ver pág. 576)



TRES TOUCH-COOL®

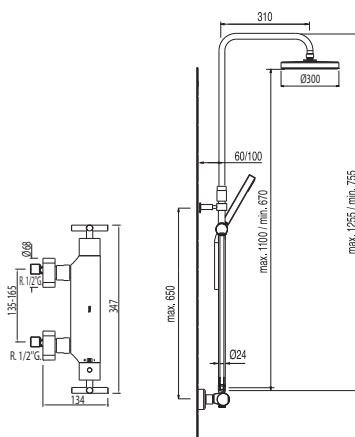

LATÓN



LATÓN

Cr

063.211.01

Conjunto bañera-ducha BIMAX termostática

Ducha fija Ø 300 mm. (1.34.137.30). Material Latón. Ducha móvil anticalcárea (034.116.01) y flexo SATIN (91.34.609.15). Barra telescópica. Inversor integrado en el regulador de caudal (ver pág. 576)



TRES TOUCH-COOL®

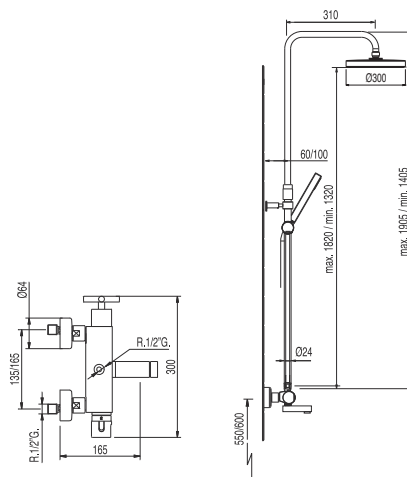

LATÓN



LATÓN

Cr

1.90.311

Cr = Cromo

BIMAX-TRES

Ref.:



Kit de ducha termostático empotrado BIMAX

con cierre y regulación de caudal. (2 vías) Ducha fija Ø 300 mm. (1.34.137.30). Material Latón. Soporte con toma pared (91.34.182). Ducha móvil anticalcárea (034.116.01) y flexo SATIN (91.34.609.15).

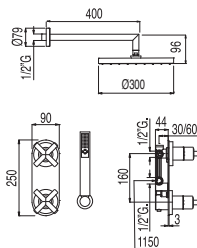

Cr 1.63.275



Kit de ducha termostático empotrado BIMAX

con cierre y regulación de caudal. (3 vías) Ducha fija Ø 300 mm. (1.34.137.30). Material Latón. 3 jets antical orientables (91.34.415). Soporte con toma pared (91.34.182). Ducha móvil anticalcárea. (034.116.01). Flexo SATIN (91.34.609.15).

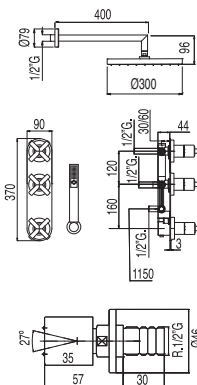

Cr 1.63.278

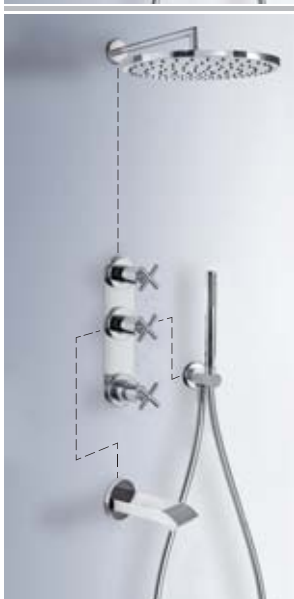

Kit de bañera termostático empotrado BIMAX

con cierre y regulación de caudal. (3 vías) Ducha fija Ø 300 mm. (1.34.137.30). Material Latón. Soporte con toma pared (91.34.182). Caño cascada (1.87.181.50). Ducha móvil anticalcárea. (034.116.01). Flexo SATIN (91.34.609.15).

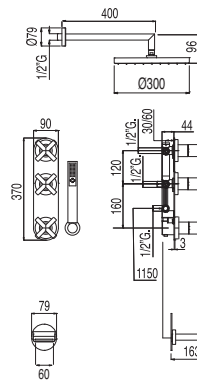

Cr 1.63.144

Cr = Cromo

Ref.:

Termostática bañera BIMAX

con caño cascada. Soporte con toma pared (91.34.182). Ducha móvil anticalcárea. (034.116.01). Flexo SATIN (91.34.609).

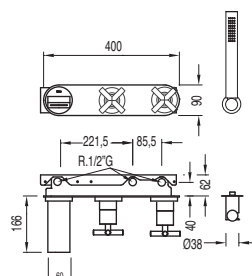

Cr 1.63.192

Llaves de paso

Ref.:

N



Llave de paso 1/2"

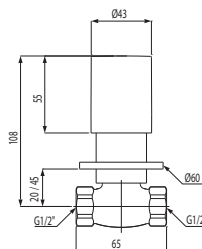

Cr 061.155.01

N



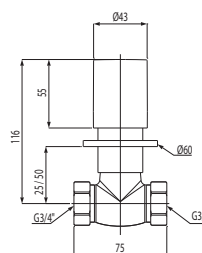

Llave de paso 3/4"



Cr 061.511.01

BIMAX-TRES

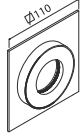
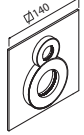
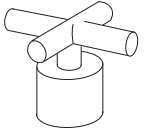
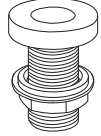
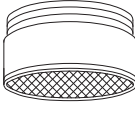
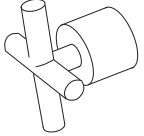
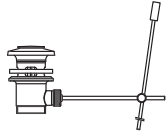
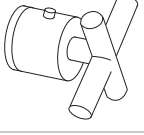
Recambios

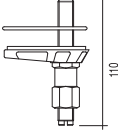
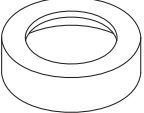
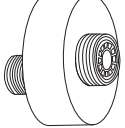
	Maneta (para ref.: 63.177, 63.180)	Cr	91.34.080		Base + florón (para ref.: 63.177)	Cr	91.62.177.10
	Cruceta completa (para ref.: 63.151, 63.152, 63.155, 63.511)	Cr	91.63.003		Base + florón (para ref.: 63.180)	Cr	91.62.180.10
		Cr	91.34.003		Soporte ducha pasamuro (para ref.: 63.145)	Cr	91.62.145.40
	(para ref.: 68.103.10, 63.103.10, 68.120.10, 63.120.10)	Cr	91.34.003.10		Casquillo + Aireador (para ref.: 63.103, 63.333, 68.105, 63.145)	Cr	92.63.774
	Cruceta termostática completa (para ref.: 63.182, 90.183, 90.193, 90.868, 90.874, 63.195, 63.395, 63.198, 63.798, 90.211, 90.393, 90.583)	Cr	91.94.183		Desagüe automático 1,1/4"	Cr	91.34.275.10
	Cruceta completa lado temperatura (para ref.: 63.164, 63.174, 63.192, 63.250, 63.251, 63.252, 63.253)	Cr	91.34.003.20		Conjunto varilla y pulsador	Cr	91.34.275
	Cartucho termostático + volante (para ref.: 90.183, 90.193, 90.868, 90.874, 90.393, 90.583)	Cr	91.94.161.01		Conjunto fijación (para ref.: 63.103.10, 63.120.10, 68.103.10, 68.120.10)	Cr	96.61.103.01
	Base grifos	Cr	91.63.103.02				
	Florón con excéntrica y silenciador	Cr	91.61.170.19				

Cr = Cromo