

ALPLUS

Lavabos

Ref.:

N



Monomando lavabo

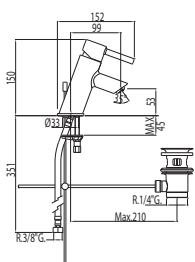

91.34.592

Cr

203.103.01



91.34.592

Cr

203.103.01.D

N



Monomando lavabo

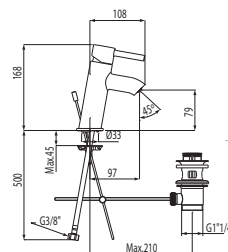

91.34.592

Cr

203.903.01



91.34.592

Cr

203.903.01.D

N



Monomando lavabo

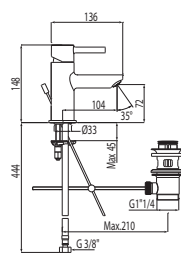

91.34.592

Cr

203.103.03



91.34.592

Cr

203.103.03.D

Cr = Cromo

Recomendado montar válvula SIMPLE RAPID (NO INCLUIDA)

Ref.:

**MEDIDAS ESPECIALES**

**N** Monomando lavabo con alargadera

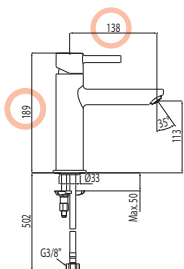
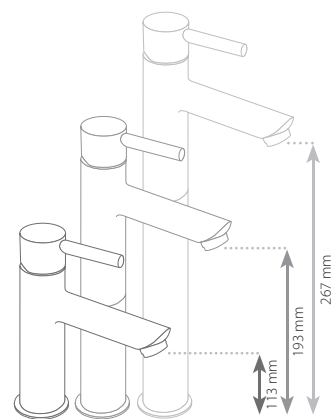
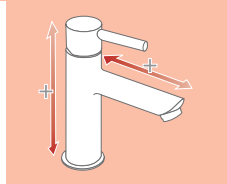

	Cr	203.203.01	
--	----	------------	--

	Cr	203.203.01.D	
--	----	--------------	--

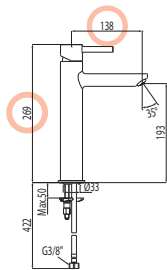

	Cr	203.217.01	
--	----	------------	--

	Cr	203.217.01.D	
--	----	--------------	--

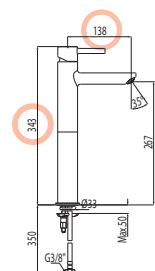

	Cr	203.207.01	
--	----	------------	--

	Cr	203.207.01.D	
--	----	--------------	--

Cr = Cromo

Recomendado montar válvula SIMPLE RAPID (NO INCLUIDA)

Ref.:

N

Monomando lavabo

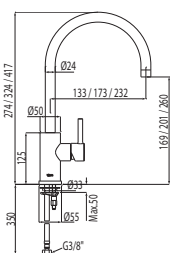
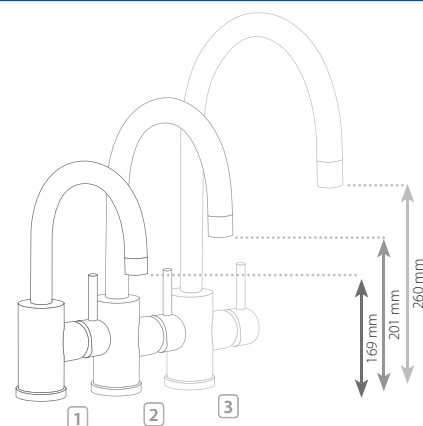

1			Cr	203.703.01
2			Cr	203.403.01
3			Cr	203.303.01



Grifo lavabo encimera  
Temporizada 6,5 l/m.

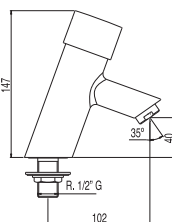

Cr	1.12.203
----	----------



Grifo lavabo 1 agua

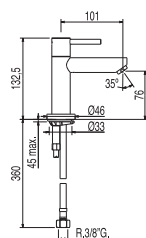

91.34.272.20	Cr	1.62.503
--------------	----	----------



Monomando lavabo Ø 30 mm.

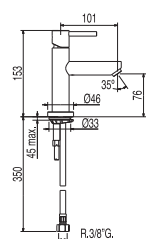









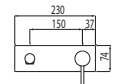

91.62.190	Cr	1.62.603
-----------	----	----------

Cr = Cromo





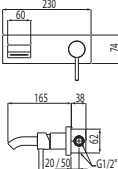

Recomendado montar válvula SIMPLE RAPID (NO INCLUIDA)



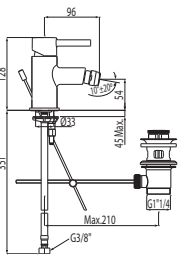



# ALPLUS



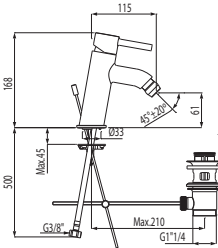



		Ref.:		
	<b>Monomando mural</b>		(16 cm.)	
			  91.34.592 Cr	203.210.01
			  91.34.592 Cr	203.200.02
		  91.34.592 Cr	(25 cm.) 203.200.01	

	<b>Monomando mural con caño cascada</b>		 91.34.592 Cr	203.260.01
---	---	---	--	------------

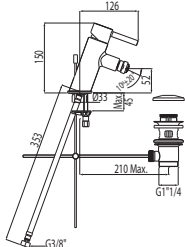
## Bidé

		Ref.:		
	<b>Monomando bidé</b>		   91.34.592 Cr	203.120.03
			   91.34.592 Cr	203.120.03.D

	<b>Monomando bidé</b>		   91.34.592 Cr	203.920.01
			   91.34.592 Cr	203.920.01.D

	<b>Monomando bidé</b>		   91.34.592 Cr	203.120.01
			   91.34.592 Cr	203.120.01.D

Cr = Cromo

 Recomendado montar válvula SIMPLE RAPID (NO INCLUIDA)

Ref.:

N



Monomando bidé

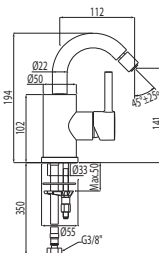

91.34.592

Cr	203.224.01
----	------------

N



Monomando bidé con ducha

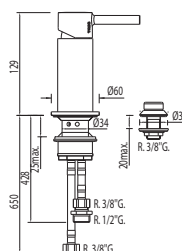

Cr	203.130.01
----	------------

N



Monomando empotrar para bidé WC ALPLUS

Soporte derecha o izquierda, cambiabile.  
Ducha de latón con record limitador 5 l/m.  
Antigoteo y flexo SATIN

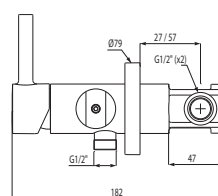

LATÓN



91.34.591

Cr	203.223.01
Cr	203.222.01*

N



Monomando lavabo para WC ALPLUS

Ducha con cierre y flexo SATIN

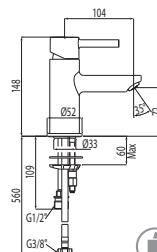

Sistema Patentado®



91.34.592.10

Cr	203.113.01
----	------------

N



Monomando empotrar para bidé WC ALPLUS

Ducha de latón con record limitador 5 l/m.  
Antigoteo y flexo SATIN

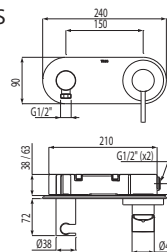

LATÓN



91.34.591

Cr	203.123.01
Cr	203.122.01*

\* Opción para paredes de Pladur

# ALPLUS

## Monomandos baño

Ref.:

N

**Monomando ducha**  
 Ducha móvil anticalcárea (299.631.03) y flexo SATIN (91.34.609.15).

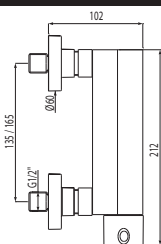

Cr

203.167.01

N

**Monomando bañera-ducha**  
 Ducha móvil anticalcárea (299.631.03) y flexo SATIN (91.34.609).

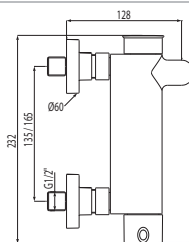

Cr

203.170.01

N

**Conjunto ducha anticalcárea ALPLUS**  
 Ducha fija Ø 225 mm. (299.632.01). Ducha móvil anticalcárea (299.631.03) y flexo SATIN (91.34.609.15).

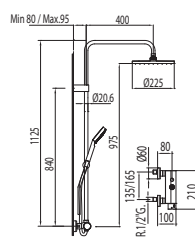

Cr

203.191.01

**Bañeras de repisa**

Ref.:

**N**

Monomando bañera de repisa  
Ducha móvil anticalcárea (299.631.03).

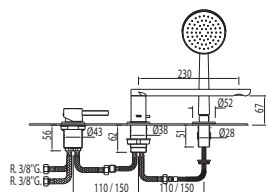

°C  
3 bar  
16 l/m



91.34.591

Cr

203.161.01

**N**

Kit depósito para bañeras de repisa  
Fácil montaje superior. Sin registros

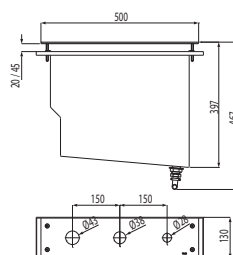

Sistema Patentado®

Cr

203.245.01



Válvula bañera con toma drenaje

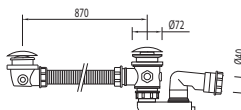

Cr

1.34.445

**Empotrados**

Ref.:

**N**

Monomando empotrar ducha

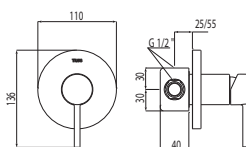

91.34.592

Cr

203.177.01

**N**

Monomando empotrar baño-ducha

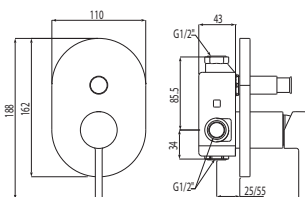

91.34.592

Cr

203.180.01

Cr = Cromo

# ALPLUS

## Conjuntos empotrados

Ref.:



**Kit de ducha empotrado ALPLUS**  
Ducha fija Ø 225 mm. (299.632.01).

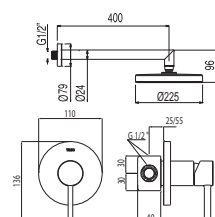

91.34.592

Cr

203.177.02



**Kit de ducha empotrado ALPLUS**  
Ducha fija Ø 225 mm. (299.632.01). Soporte con toma pared (91.34.182).  
Ducha móvil anticalcárea (299.631.03) y flexo SATIN (91.34.609.15).

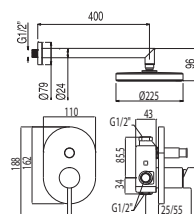

91.34.592

Cr

203.180.02



**Kit de ducha empotrado ALPLUS**  
Ducha fija Ø 225 mm. (299.632.01). Codo toma pared (1.34.758).  
Barra deslizante long. 550 mm. (1.34.618). Ducha móvil anticalcárea  
(299.631.03) y flexo SATIN (91.34.609.15).

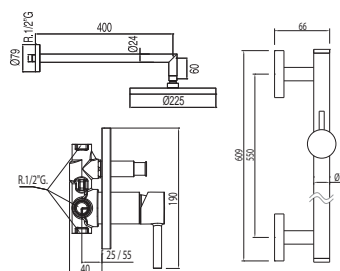

91.34.592

Cr

203.180.03

Cr = Cromo



**Monomando baño MONO-TERM®**

Ref.:

**MONO-TERM® ducha**  
 Ducha móvil masaje Ø 100 mm. (5 funciones)  
 (1.34.748). Flexo SATIN (91.34.609.15).

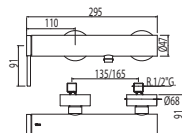

TRES TOUCH-COOL®

Cr 201.167.01

**MONO-TERM® bañera-ducha**  
 Ducha móvil masaje Ø 100 mm. (5 funciones)  
 (1.34.748). Flexo SATIN (91.34.609).

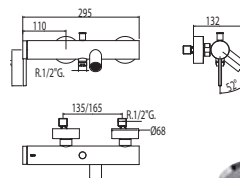

TRES TOUCH-COOL®

Cr 201.170.01

**Empotrados MONO-TERM®**

Ref.:

**MONO-TERM® de empotrar ducha**  
 con cierre y regulación de caudal

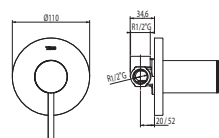

Cr 201.177.02

**MONO-TERM® de empotrar baño-ducha**  
 con cierre y regulación de caudal

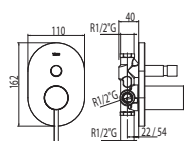

Cr 201.180.02

Cr = Cromo

**Conjuntos MONO-TERM®**

Ref.:



**Kit MONO-TERM® de empotrar ducha**

con cierre y regulación de caudal. Ducha fija Ø 225 mm. (299.632.01).  
Ducha móvil masaje Ø 100 mm. (5 funciones) (1.34.748) y flexo SATIN (91.34.609.15). Con toma pared

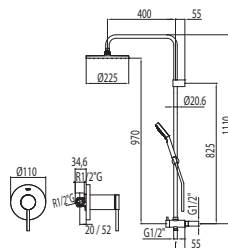

Cr 201.177.03



**Kit MONO-TERM® de empotrar ducha**

con cierre y regulación de caudal. Ducha fija Ø 250 mm. (1.34.137.26). Soporte con toma pared (91.34.182). Ducha móvil masaje Ø 100 mm. (5 funciones) (1.34.748) y flexo SATIN (91.34.609.15).

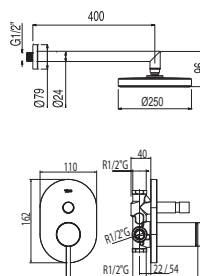

Cr 201.180.03



**Barra de ducha MONO-TERM®**

Ducha fija Ø 250 mm. (1.34.137.26). Ducha móvil masaje Ø 100 mm. (5 funciones) (1.34.748) y flexo SATIN (91.34.609.15). Barra telescópica.

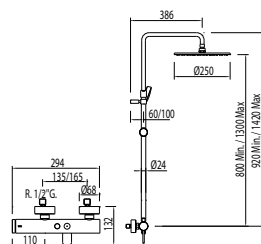

Cr 201.195.01

TRES TOUCH-COOL

Cr = Cromo

Termostáticas

Ref.:

Ducha ALPLUS-LEX termostática  
(Ducha móvil anticalcárea (299.631.03)  
y flexo SATIN (91.34.609.15)).

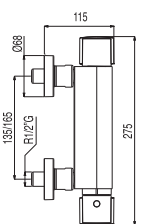

Cr

1.81.164



Cr

203.164.09

Bañera-ducha ALPLUS-LEX  
termostática  
(Ducha móvil anticalcárea (299.631.03)  
y flexo SATIN (91.34.609)).

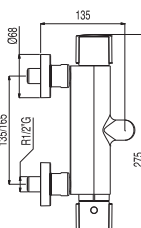

Cr

1.81.174



Cr

203.174.09

Ducha termostática  
Ducha anticalcárea (299.631.03) y flexo SATIN  
(91.34.609.15). **Indicado para personas con  
discapacidades físicas**

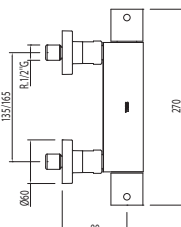

Cr

090.964.01



Bañera-ducha termostática  
Ducha anticalcárea (299.631.03) y flexo SATIN  
(91.34.609). **Indicado para personas con  
discapacidades físicas**

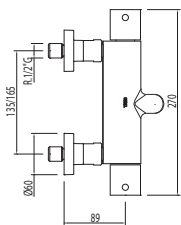

Cr

090.974.01



2 tomas suelo de bañera  
Con soporte giratorio

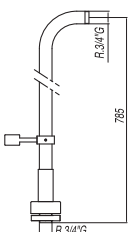

Cr

1.61.194

# ALPLUS

## Conjuntos termostáticos

Ref.:



### Conjunto ducha ALPLUS termostática

Ducha fija Ø 250 mm. (1.34.137.26). Ducha móvil anticalcárea (299.631.03) y flexo SATIN (91.34.609.15). Barra telescópica. Inversor integrado en el regulador de caudal (ver pág. 576)

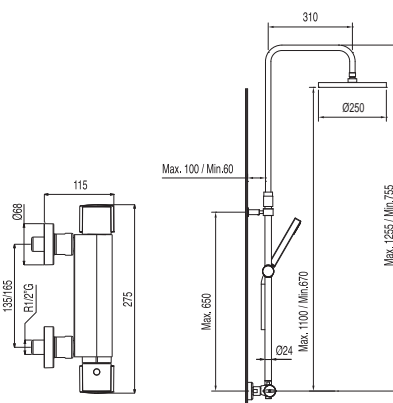

TRES TOUCH-COOL

Cr 203.385.03



### Conjunto ducha ALPLUS termostática

Ducha fija Ø 225 mm. (299.632.01). Ducha móvil anticalcárea (299.631.03) y flexo SATIN (91.34.609.15). Inversor integrado en el regulador de caudal (ver pág. 576)

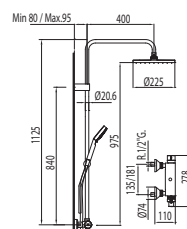

TRES TOUCH-COOL

Cr 203.385.01



### Conjunto ducha ALPLUS termostática

Ducha fija Ø 225 mm. (299.632.01). Ducha móvil anticalcárea (299.631.03) y flexo SATIN (91.34.609.15).

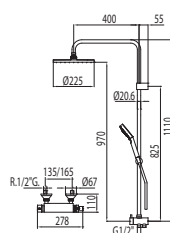

Cr 203.385.02

Cr = Cromo

Ref.:



**Kit de ducha termostático empotrado ALPLUS**

con cierre y regulación de caudal. (2 vías) Ducha fija Ø 250 mm. (1.34.137.26). Soporte con toma pared (91.34.182). Ducha móvil anticalcárea (299.631.03) y flexo SATIN (91.34.609.15).

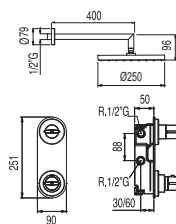

Cr

203.175.01

# ALPLUS

## PACK MASTER



**N** Ref.: 203.537.07



**N** Ref.: 203.537.04



**N** Ref.: 203.537.01



**RENEVA TU BAÑO**

## Recambios

	<b>Maneta</b>	Cr 91.34.095		<b>Conjunto distribuidor</b> (para ref.: 203.170.01)	Cr 91.34.260
	<b>Maneta</b> (para ref.: 203.167.01, 203.170.01)	Cr 91.34.095.20		<b>Aireador</b> (para ref.: 62.503, 62.603) M.18x1	Cr 92.62.503
	<b>Volante lado caudal</b> (para ref.: 81.164, 81.174, 203.164, 203.174)	Cr 91.81.081.02		<b>Desagüe automático</b> 1,1/4"	Cr 91.34.275.10
	<b>Volante lado temperatura</b> (para ref.: 81.164, 81.174, 203.164, 203.174)	Cr 91.81.081.01		<b>Conjunto varilla y pulsador</b>	Cr 91.34.275
	<b>Base monomando lavabo y bidé</b>	Cr 91.83.100.01		<b>Montura cerámica</b> (para ref.: 62.503)	91.34.272.20
	<b>Florón con excéntrica y silenciador</b>	Cr 91.81.170.09			