

CUB-TRES

Lavabos

Ref.:

Monomando lavabo

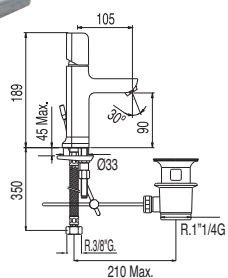

Cr 1.87.103



Cr 1.87.103.DA



Cr 1.89.103



Cr 1.89.103.DA

Bidé

Ref.:

Monomando bidé

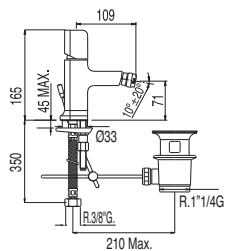

Cr 1.87.120



Cr 1.87.120.DA



Cr 1.89.120



Cr 1.89.120.DA

Cr = Cromo

Recomendado montar válvula SIMPLE RAPID (NO INCLUIDA)

CUB-TRES

Empotrados

Ref.:

Monomando empotrar ducha

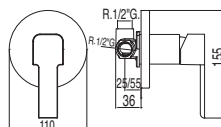

91.34.592

Cr

1.89.177

Monomando empotrar baño-ducha

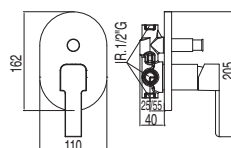

91.34.592

Cr

1.89.180

Conjuntos empotrados

Ref.:



Kit de ducha monomando empotrado CUB

con cierre y regulación de caudal. Ducha fija 300x300 mm. (1.34.138.30).
Material Latón.

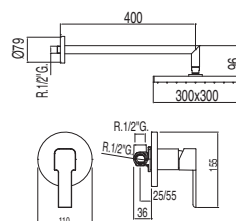

LATÓN



91.34.592

Cr

1.89.377

Cr = Cromo

Ref.:



Kit de ducha monomando empotrado CUB

con cierre y regulación de caudal. Ducha fija 300x300 mm. (1.34.138.30).
Material Latón. Soporte con toma pared (91.34.182). Ducha móvil anticalcárea (034.116.01) y flexo SATIN (91.34.609.15).

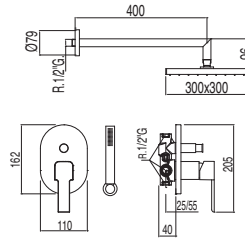

Cr

1.89.980

Bañeras de repisa

Ref.:

Monomando bañera de repisa CUB

Ducha móvil anticalcárea (034.116.01).



°C
3 bar
14 l/m

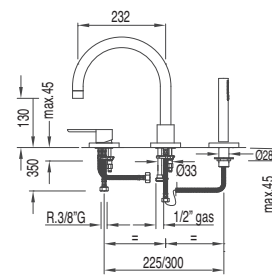

Cr

1.87.150



Cr

1.89.150



Monomando bañera de repisa CUB

Con cascada. Ducha móvil anticalcárea (034.116.01).



°C
3 bar
17 l/m

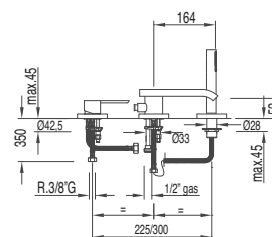

Cr

1.87.161



Cr



1.89.161





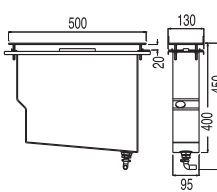

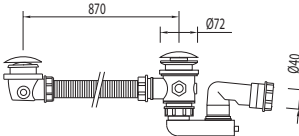

Cr = Cromo



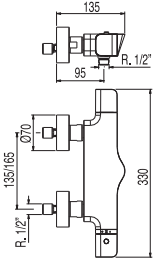



CUB-TRES

	Kit depósito para bañeras de repisa Fácil montaje superior. Sin registros		Ref.:
Cr	1.89.245		

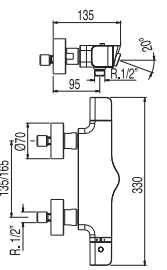
	Válvula bañera con toma drenaje		

Termostáticas

	Ducha CUB termostática (Ducha móvil anticalcárea (034.116.01) y flexo SATIN (91.34.609.15)).		Ref.:
  		 LATÓN	Cr 1.87.164.9

	Bañera-ducha CUB termostática (Ducha móvil anticalcárea (034.116.01) y flexo SATIN (91.34.609)).		Ref.:
  		 LATÓN	Cr 1.87.174.9

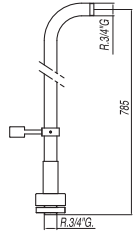
	2 tomas suelo de bañera Con soporte giratorio		Ref.:

Cr = Cromo

Conjuntos termostáticos

Ref.:

Conjunto ducha CUB termostática

Ducha fija 300x300 mm. Material Latón (1.34.138.30). Ducha móvil anticalcárea (034.116.01) y flexo SATIN (91.34.609.15). Inversor integrado en el regulador de caudal (ver pág. 576)

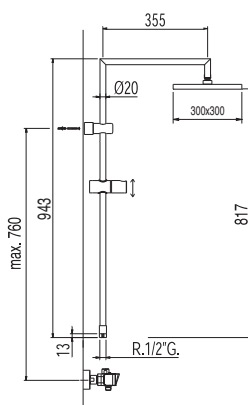

LATÓN



LATÓN



TRES TOUCH-COOL®

Cr 1.87.393

Conjunto ducha CUB termostática

Ducha fija 300x300 mm. Material Latón (1.34.138.30). Ducha móvil anticalcárea (034.116.01) y flexo SATIN (91.34.609.15). Barra telescópica. Inversor integrado en el regulador de caudal (ver pág. 576)

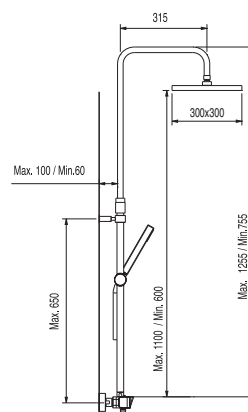

LATÓN



LATÓN



TRES TOUCH-COOL®

Cr 1.87.355

Conjunto bañera-ducha CUB termostática

Ducha fija 300x300 mm. Material Latón (1.34.138.30). Ducha móvil anticalcárea (034.116.01) y flexo SATIN (91.34.609). Barra telescópica. Inversor integrado en el regulador de caudal (ver pág. 576)

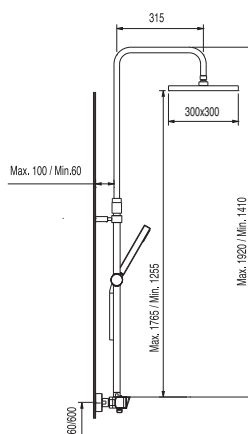

LATÓN



LATÓN



TRES TOUCH-COOL®

Cr 1.87.356

Cr = Cromo

CUB-TRES

Ref.:



Kit de ducha termostático empotrado CUB
 con cierre y regulación de caudal. (2 vías) Ducha fija 300x300 mm.
 Material Latón (1.34.138.30). Soporte con toma pared (91.34.182).
 Ducha móvil anticalcárea (034.116.01) y flexo SATIN (91.34.609.15).

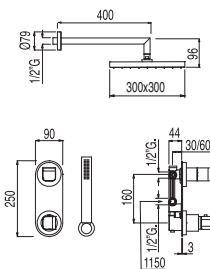

LATÓN



LATÓN



Cr **1.87.175**

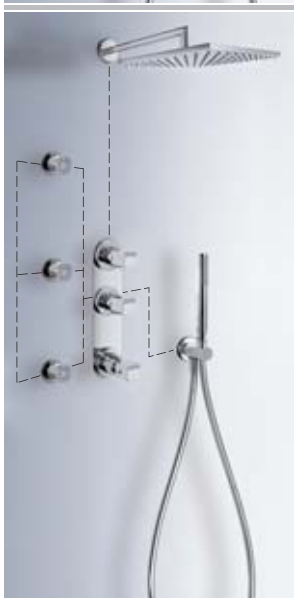

Kit de ducha termostático empotrado CUB
 con cierre y regulación de caudal. (3 vías) Ducha fija 300x300 mm.
 Material Latón (1.34.138.30). Soporte con toma pared (91.34.182). 3 jets
 antical orientables (91.34.415). Ducha móvil anticalcárea (034.116.01) y
 flexo SATIN (91.34.609.15).

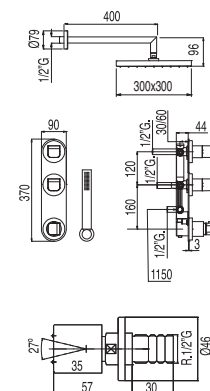

LATÓN



LATÓN



Cr **1.87.178**



Kit de bañera termostático empotrado CUB
 con cierre y regulación de caudal. (3 vías) Ducha fija 300x300 mm. Material Latón
 (1.34.138.30). Soporte con toma pared (91.34.182). Caño cascada (1.87.181.50).
 Ducha móvil anticalcárea (034.116.01) y flexo SATIN (91.34.609.15).

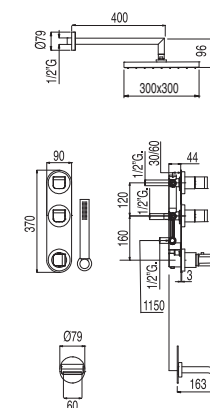

LATÓN



LATÓN



Cr **1.87.144**

Cr = Cromo

Ref.:

Termostática bañera CUB

con caño cascada. Soporte con toma pared (91.34.182). Ducha móvil anticalcárea (034.116.01) y flexo SATIN (91.34.609).



TRES BLOCK-SYSTEM

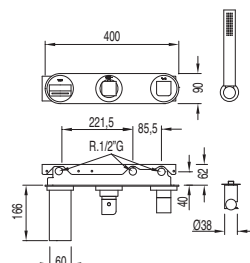

LATÓN

Cr 1.87.192

Caño cascada bañera-ducha

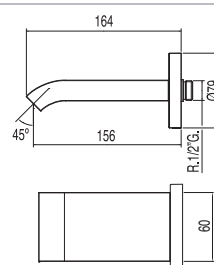

Cr 1.87.181.50



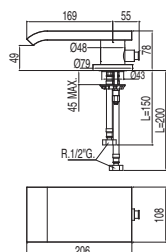



Caño cascada

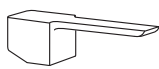

Cr 1.62.161.50

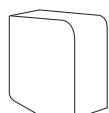
CUB-TRES

Recambios

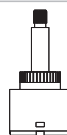
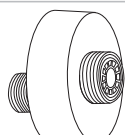
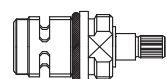
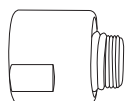
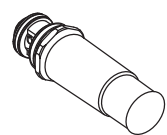
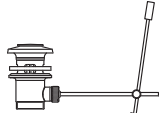
 <p>Maneta</p> <p>Cr 91.34.089</p>	 <p>Conjunto varilla y pulsador</p> <p>Cr 91.34.275</p>
 <p>Volante</p> <p>Cr 91.34.087 Nog 91.34.087.60</p>	 <p>Cartucho Ø 35 mm.</p> <p>91.34.592</p>
 <p>Cartucho termostático + volante (para ref.: 87.164, 87.174)</p> <p>Cr 91.87.161.10 Nog 91.87.161.60</p>	 <p>Cartucho distribuidor termostáticas. 2 salidas</p> <p>91.94.283</p>
 <p>Cartucho termostático + volante (para ref.: 87.250, 87.251, 87.252, 87.253, 87.192)</p> <p>Cr 91.87.161.50 Nog 91.87.161.56</p>	 <p>Cartucho distribuidor (para ref.: 87.135, 87.175, 87.176, 87.178, 87.179, 87.182, 87.183, 87.184, 87.185)</p> <p>91.34.235</p>
 <p>Florón con excéntrica y silenciador</p> <p>Cr 91.61.170.19</p>	 <p>Montura (para ref.: 87.164)</p> <p>91.34.282</p>
 <p>Conjunto pestaña con válvula antirretorno (para duchas y bañeras termostáticas)</p> <p>Cr 91.34.789.03</p>	 <p>Conjunto distribuidor (para ref.: 89.180)</p> <p>Cr 91.62.180.05</p>
 <p>Desagüe automático 1,1/4"</p> <p>Cr 91.34.275.10</p>	

Cr = Cromo Nog = Grifo cromado con volante de Nogal